

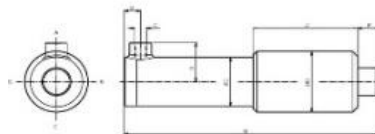

Zylinder

Falls der von Ihnen gewünschte Artikel nicht aufgeführt ist,
stehen wir Ihnen gerne mit Rat und Tat zur Verfügung

Hydraulikzylinder einfachwirkend ohne Befestigung				
Bestell-Nr.	Ø Stange mm	Hub mm	Druck max. bar	Einbaumaß mm
Zylinder EPL 20-100 EW	20	100	250	200
Zylinder EPL 30-200 EW	30	200	250	316
Zylinder EPL 30-250 EW	30	250	250	366
Zylinder EPL 30-300 EW	30	300	250	416
Zylinder EPL 30-350 EW	30	350	250	466
Zylinder EPL 30-400 EW	30	400	250	516
Zylinder EPL 30-500 EW	30	500	250	616
Zylinder EPL 40-200 EW	40	200	250	339
Zylinder EPL 40-250 EW	40	250	250	389
Zylinder EPL 40-300 EW	40	300	250	432
Zylinder EPL 40-350 EW	40	350	250	489
Zylinder EPL 40-400 EW	40	400	250	532
Zylinder EPL 40-500 EW	40	500	250	632
Zylinder EPL 50-300 EW	50	300	250	456
Zylinder EPL 50-400 EW	50	400	250	556
Zylinder EPL 50-500 EW	50	500	250	656
Zylinder EPL 50-600 EW	50	600	250	756
Zylinder EPL 60-300 EW	60	300	250	470
Zylinder EPL 60-400 EW	60	400	250	570
Zylinder EPL 60-500 EW	60	500	250	670
Zylinder EPL 60-600 EW	60	600	250	770





Hydraulikzylinder einfachwirkend mit Befestigung (Bohrung)					
Bestell-Nr.	Ø Stange mm	Ø Bolzen mm	Hub mm	Druck max. bar	Einbaumaß mm
Zylinder EW 20-100ST	20	10,2 / 10,2	100	250	178
Zylinder EW 20-150ST	20	10,2 / 10,2	150	250	228
Zylinder EW 20-200ST	20	10,2 / 10,2	200	250	278
Zylinder EW 20-250ST	20	10,2 / 10,2	250	250	328
Zylinder EW 25-100CB	25	14,2 / 14,2	100	250	190
Zylinder EW 25-200CB	25	14,2 / 14,2	200	250	290
Zylinder EW 25-300CB	25	14,2 / 14,2	300	250	390
Zylinder EW 30-100ST	30	15,2 / 15,2	100	250	204
Zylinder EW 30-200CB	30	16,2 / 16,2	200	250	300
Zylinder EW 30-300CB	30	16,2 / 16,2	300	250	400
Zylinder EW 30-350ST	30	15,2 / 15,2	350	250	454
Zylinder EW 30-400CB	30	16,2 / 16,2	400	250	500
Zylinder EW 30-500ST	30	15,2 / 15,2	500	250	604
Zylinder EW 30-550CB	30	16,2 / 16,2	550	250	650
Zylinder EW 30-600ST	30	15,2 / 15,2	600	250	704
Zylinder EW 30-700CB	30	16,2 / 16,2	700	250	800
Zylinder EW 40-200CB	40	23 / 23	200	250	330
Zylinder EW 40-250CB	40	23 / 23	250	250	480
Zylinder EW 40-300CB	40	23 / 23	300	250	432
Zylinder EW 40-350ST	40	20,4 / 20,4	350	250	482
Zylinder EW 40-400CB	40	23 / 23	400	250	532
Zylinder EW 40-550CB	40	23 / 23	550	250	680
Zylinder EW 40-600ST	40	20,4 / 20,4	600	250	732
Zylinder EW 40-700CB	40	23 / 23	700	250	830
Zylinder EW 45-200CB	45	23 / 23	200	250	330
Zylinder EW 45-300CB	45	23 / 23	300	250	430
Zylinder EW 45-400CB	45	23 / 23	400	250	530
Zylinder EW 45-550CB	45	23 / 23	550	250	680
Zylinder EW 45-700CB	45	23 / 23	700	250	830
Zylinder EW 50-200CB	50	25,25 / 25,25	200	250	361
Zylinder EW 50-300CB	50	25,25 / 25,25	300	250	461
Zylinder EW 50-400CB	50	25,25 / 25,25	400	250	561
Zylinder EW 50-500ST	50	25,4 / 25,4	500	250	661
Zylinder EW 50-550CB	50	25,25 / 25,25	550	250	710
Zylinder EW 50-600ST	50	25,4 / 25,4	600	250	761
Zylinder EW 50-700 CB	50	25,25 / 25,25	700	250	860

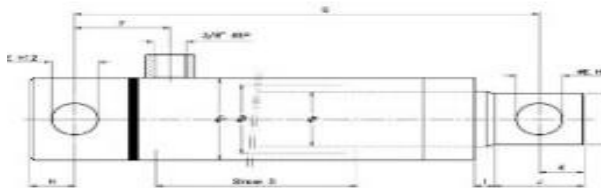



Hydraulikzylinder einfachwirkend mit Befestigung (Bohrung)

Bestell-Nr.	Ø Stange mm	Ø Bolzen mm	Hub mm	Druck max. bar	Einbaumaß mm
Zylinder EW 55-300CB	55	25,25 / 25,25	300	250	460
Zylinder EW 55-550CB	55	25,25 / 25,25	550	250	710
Zylinder EW 55-700CB	55	25,25 / 25,25	700	250	860
Zylinder EW 60-200CB	60	25,25 / 25,25	200	250	360
Zylinder EW 60-300CB	60	25,25 / 25,25	300	250	460
Zylinder EW 60-400CB	60	25,25 / 25,25	400	250	570
Zylinder EW 60-550CB	60	25,25 / 25,25	550	250	710
Zylinder EW 60-700CB	60	25,25 / 25,25	700	250	860
Zylinder EW 70-300CB	70	30,25 / 30,25	300	250	509
Zylinder EW 70-400CB	70	30,25 / 30,25	400	250	609
Zylinder EW 70-500CB	70	30,25 / 30,25	500	250	709

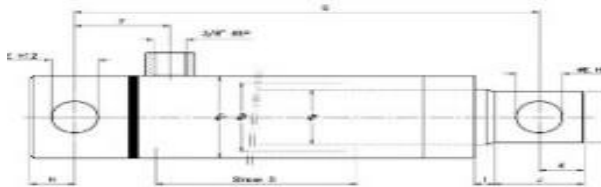



Hydraulikzylinder doppelwirkend ohne Befestigung

Bestell-Nr.	Ø Stange mm	Ø Kolben mm	Hub mm	Ø Bolzen	Druck max. bar	Einbaumaß mm
Zylinder DW 16-25-100	16	25	100	1/4"	250	230
Zylinder DW 16-25-125	16	25	125	1/4"	250	255
Zylinder DW 16-25-150	16	25	150	1/4"	250	280
Zylinder DW 16-25-175	16	25	175	1/4"	250	305
Zylinder DW 16-25-200	16	25	200	1/4"	250	330
Zylinder DW 16-25-250	16	25	250	1/4"	250	380
Zylinder DW 20-30-100	20	30	100	1/4"	250	236
Zylinder DW 20-30-125	20	30	125	1/4"	250	261
Zylinder DW 20-30-150	20	30	150	1/4"	250	286
Zylinder DW 20-30-175	20	30	175	1/4"	250	311
Zylinder DW 20-30-200	20	30	200	1/4"	250	336
Zylinder DW 20-30-250	20	30	250	1/4"	250	386
Zylinder DW 20-30-300	20	30	300	1/4"	250	436
Zylinder DW 20-30-350	20	30	350	1/4"	250	486
Zylinder DW 25-40-100	25	40	100	3/8"	250	246
Zylinder DW 25-40-125	25	40	125	3/8"	250	271
Zylinder DW 25-40-150	25	40	150	3/8"	250	296
Zylinder DW 25-40-175	25	40	175	3/8"	250	321
Zylinder DW 25-40-200	25	40	200	3/8"	250	346
Zylinder DW 25-40-250	25	40	250	3/8"	250	396
Zylinder DW 25-40-300	25	40	300	3/8"	250	446
Zylinder DW 25-40-350	25	40	350	3/8"	250	496
Zylinder DW 25-40-400	25	40	400	3/8"	250	546
Zylinder DW 25-40-450	25	40	450	3/8"	250	596
Zylinder DW 25-40-500	25	40	500	3/8"	250	646
Zylinder DW 25-40-600	25	40	600	3/8"	250	746
Zylinder DW 25-50x100	25	50	100	3/8"	250	256
Zylinder DW 25-50x125	25	50	125	3/8"	250	281
Zylinder DW 25-50-150	25	50	150	3/8"	250	306
Zylinder DW 25-50-175	25	50	175	3/8"	250	331
Zylinder DW 25-50-200	25	50	200	3/8"	250	356
Zylinder DW 25-50-250	25	50	250	3/8"	250	406
Zylinder DW 25-50-300	25	50	300	3/8"	250	456
Zylinder DW 25-50-350	25	50	350	3/8"	250	506
Zylinder DW 25-50-400	25	50	400	3/8"	250	556
Zylinder DW 25-50-450	25	50	450	3/8"	250	606
Zylinder DW 25-50-500	25	50	500	3/8"	250	656
Zylinder DW 25-50-600	25	50	600	3/8"	250	756
Zylinder DW 25-50-700	25	50	700	3/8"	250	856
Zylinder DW 25-50-800	25	50	800	3/8"	250	956
Zylinder DW 25-50-1000	25	50	1000	3/8"	250	1156

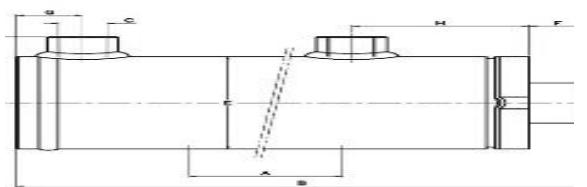



Hydraulikzylinder doppelwirkend ohne Befestigung

Bestell-Nr.	Ø Stange mm	Ø Kolben mm	Hub mm	Ø Bolzen	Druck max. bar	Einbaumaß mm
Zylinder DW 30-60-125	30	60	125	3/8"	250	285
Zylinder DW 30-60-150	30	60	150	3/8"	250	310
Zylinder DW 30-60-175	30	60	175	3/8"	250	335
Zylinder DW 30-60-200	30	60	200	3/8"	250	360
Zylinder DW 30-60-250	30	60	250	3/8"	250	410
Zylinder DW 30-60-300	30	60	300	3/8"	250	460
Zylinder DW 30-60-350	30	60	350	3/8"	250	510
Zylinder DW 30-60-400	30	60	400	3/8"	250	560
Zylinder DW 30-60-450	30	60	450	3/8"	250	610
Zylinder DW 30-60-500	30	60	500	3/8"	250	660
Zylinder DW 30-60-600	30	60	600	3/8"	250	760
Zylinder DW 30-60-800	30	60	800	3/8"	250	960
Zylinder DW 30-60-1000	30	60	1000	3/8"	250	1160
Zylinder DW 35-70-100	35	70	100	3/8"	250	276
Zylinder DW 35-70-125	35	70	125	3/8"	250	301
Zylinder DW 35-70-150	35	70	150	3/8"	250	326
Zylinder DW 35-70-175	35	70	175	3/8"	250	351
Zylinder DW 35-70-200	35	70	200	3/8"	250	376
Zylinder DW 35-70-250	35	70	250	3/8"	250	426
Zylinder DW 35-70-300	35	70	300	3/8"	250	476
Zylinder DW 35-70-350	35	70	350	3/8"	250	526
Zylinder DW 35-70-400	35	70	400	3/8"	250	576
Zylinder DW 35-70-450	35	70	450	3/8"	250	626
Zylinder DW 35-70-500	35	70	500	3/8"	250	676
Zylinder DW 35-70-600	35	70	600	3/8"	250	776
Zylinder DW 35-70-800	35	70	800	3/8"	250	979
Zylinder DW 35-70-1000	35	70	1000	3/8"	250	1176
Zylinder DW 45-80-100	45	80	100	1/2"	250	291
Zylinder DW 45-80-125	45	80	125	1/2"	250	316
Zylinder DW 45-80-150	45	80	150	1/2"	250	341
Zylinder DW 45-80-175	45	80	175	1/2"	250	366
Zylinder DW 45-80-200	45	80	200	1/2"	250	391
Zylinder DW 45-80-250	45	80	250	1/2"	250	441
Zylinder DW 45-80-300	45	80	300	1/2"	250	491
Zylinder DW 45-80-350	45	80	350	1/2"	250	541
Zylinder DW 45-80-400	45	80	400	1/2"	250	591
Zylinder DW 45-80-450	45	80	450	1/2"	250	641
Zylinder DW 45-80-500	45	80	500	1/2"	250	691
Zylinder DW 45-80-600	45	80	600	1/2"	250	791
Zylinder DW 45-80-800	45	80	800	1/2"	250	991
Zylinder DW 45-80-900	45	80	900	1/2"	250	1091
Zylinder DW 45-80-1000	45	80	1000	1/2"	250	1191

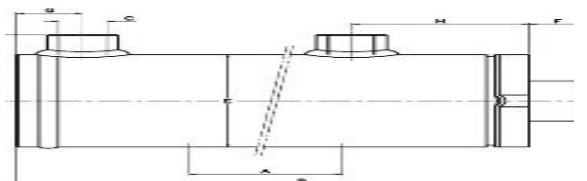



Hydraulikzylinder doppelwirkend mit Befestigung (Bohrung)

Bestell-Nr.	Ø Stange mm	Ø Kolben mm	Hub mm	Ø Bolzen mm	Druck max. bar	Einbaumaß mm
Zylinder DW 16-32-50ST	16	32	50	15,2 / 15,2	250	184
Zylinder DW 16-32-100ST	16	32	100	15,2 / 15,2	250	234
Zylinder DW 16-32-150ST	16	32	150	15,2 / 15,2	250	284
Zylinder DW 16-32-200ST	16	32	200	15,2 / 15,2	250	334
Zylinder DW 20-32-300CB	20	32	300	16,2 / 16,2	250	455
Zylinder DW 20-32-400CB	20	32	400	16,2 / 16,2	250	555
Zylinder DW 20-32-500CB	20	32	500	16,2 / 16,2	250	655
Zylinder DW 20-32-600CB	20	32	600	16,2 / 16,2	250	755
Zylinder DW 20-32-700CB	20	32	700	16,2 / 16,2	250	855
Zylinder DW 25-40-100ST	25	40	100	20,4 / 20,4	250	246
Zylinder DW 25-40-200ST	25	40	200	20,4 / 20,4	250	346
Zylinder DW 25-40-250ST	25	40	250	20,4 / 20,4	250	396
Zylinder DW 25-40-300ST	25	40	300	20,4 / 20,4	250	446
Zylinder DW 25-40-400ST	25	40	400	20,4 / 20,4	250	546
Zylinder DW 25-40-500ST	25	40	500	20,4 / 20,4	250	646
Zylinder DW 25-40-600CB	25	40	600	20,3 / 20,3	250	670
Zylinder DW 25-40-700CB	25	40	700	20,3 / 20,3	250	870
Zylinder DW 25-40-800CB	25	40	800	20,3 / 20,3	250	970
Zylinder DW 25-40-900CB	25	40	900	20,3 / 20,3	250	1070
Zylinder DW 30-50-100CB	30	50	100	25,3 / 25,3	250	300
Zylinder DW 30-50-200ST	30	50	200	25,4 / 25,4	250	373
Zylinder DW 30-50-250ST	30	50	250	25,4 / 25,4	250	423
Zylinder DW 30-50-300ST	30	50	300	25,4 / 25,4	250	473
Zylinder DW 30-50-350ST	30	50	350	25,4 / 25,4	250	523
Zylinder DW 30-50-400ST	30	50	400	25,4 / 25,4	250	573
Zylinder DW 30-50-500ST	30	50	500	25,4 / 25,4	250	673
Zylinder DW 30-50-600ST	30	50	600	25,4 / 25,4	250	773
Zylinder DW 30-50-700ST	30	50	700	25,4 / 25,4	250	873
Zylinder DW 30-50-800CB	30	50	800	25,3 / 25,3	250	1000
Zylinder DW 30-50-900ST	30	50	900	25,4 / 25,4	250	1073
Zylinder DW 30-50-1000CB	30	50	1000	25,3 / 25,3	250	1200
Zylinder DW 30-60-100CB	30	60	100	25,3 / 25,3	250	300
Zylinder DW 30-60-200ST	30	60	200	25,4 / 25,4	250	373
Zylinder DW 30-60-250ST	30	60	250	25,4 / 25,4	250	423
Zylinder DW 30-60-300ST	30	60	300	25,4 / 25,4	250	473
Zylinder DW 30-60-400ST	30	60	400	25,4 / 25,4	250	573
Zylinder DW 30-60-500ST	30	60	500	25,4 / 25,4	250	673
Zylinder DW 30-60-600ST	30	60	600	25,4 / 25,4	250	773
Zylinder DW 30-60-700ST	30	60	700	25,4 / 25,4	250	873
Zylinder DW 30-60-1000ST	30	60	1000	25,4 / 25,4	250	1173

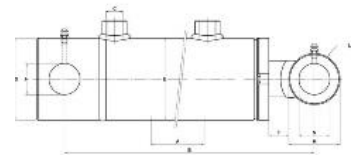



Hydraulikzylinder doppelwirkend mit Befestigung (Bohrung)

Bestell-Nr.	Ø Stange mm	Ø Kolben mm	Hub mm	Ø Bolzen mm	Druck max. bar	Einbaumaß mm
Zylinder DW 35-60-200ST	35	60	200	25,4 / 25,4	250	373
Zylinder DW 35-60-250ST	35	60	250	25,4 / 25,4	250	423
Zylinder DW 35-60-300ST	35	60	300	25,4 / 25,4	250	473
Zylinder DW 35-60-400ST	35	60	400	25,4 / 25,4	250	573
Zylinder DW 35-60-500ST	35	60	500	25,4 / 25,4	250	673
Zylinder DW 35-60-600ST	35	60	600	25,4 / 25,4	250	773
Zylinder DW 35-60-700ST	35	60	700	25,4 / 25,4	250	873
Zylinder DW 35-60-1000ST	35	60	1000	25,4 / 25,4	250	1173
Zylinder DW 35-70-200ST	35	70	200	30,4 / 30,4	250	396
Zylinder DW 35-70-250ST	35	70	250	30,4 / 30,4	250	446
Zylinder DW 35-70-300ST	35	70	300	30,4 / 30,4	250	496
Zylinder DW 35-70-400ST	35	70	400	30,4 / 30,4	250	596
Zylinder DW 35-70-500ST	35	70	500	30,4 / 30,4	250	696
Zylinder DW 35-70-600ST	35	70	600	30,4 / 30,4	250	796
Zylinder DW 40-70-700CB	40	70	700	30,3 / 30,3	250	910
Zylinder DW 40-70-800CB	40	70	800	30,3 / 30,3	250	1010
Zylinder DW 40-70-1000CB	40	70	1000	30,3 / 30,3	250	1210
Zylinder DW 40-80-200CB	40	80	200	30,3 / 30,3	250	410
Zylinder DW 40-80-250ST	40	80	250	30,4 / 30,4	250	455
Zylinder DW 40-80-300ST	40	80	300	30,4 / 30,4	250	505
Zylinder DW 40-80-400ST	40	80	400	30,4 / 30,4	250	660
Zylinder DW 40-80-500ST	40	80	500	30,4 / 30,4	250	705
Zylinder DW 40-80-600ST	40	80	600	30,4 / 30,4	250	808
Zylinder DW 40-80-700ST	40	80	700	30,4 / 30,4	250	905
Zylinder DW 40-80-800ST	40	80	800	30,4 / 30,4	250	1005
Zylinder DW 40-80-900ST	40	80	900	30,4 / 30,4	250	1105
Zylinder DW 40-80-1000ST	40	80	1000	30,4 / 30,4	250	1205
Zylinder DW 50-80-300ST	50	80	300	30,4 / 30,4	250	505
Zylinder DW 50-80-400ST	50	80	400	30,4 / 30,4	250	605
Zylinder DW 50-80-500ST	50	80	500	30,4 / 30,4	250	705
Zylinder DW 50-80-600ST	50	80	600	30,4 / 30,4	250	805
Zylinder DW 50-80-700ST	50	80	700	30,4 / 30,4	250	905
Zylinder DW 50-80-900ST	50	80	900	30,4 / 30,4	250	1105
Zylinder DW 50-100-200ST	50	100	200	30,3 / 30,3	250	436
Zylinder DW 50-100-300CB	50	100	300	30,3 / 30,3	250	525
Zylinder DW 50-100-400CB	50	100	400	30,3 / 30,3	250	625
Zylinder DW 50-100-500CB	50	100	500	30,3 / 30,3	250	725
Zylinder DW 50-100-700CB	50	100	700	30,3 / 30,3	250	925
Zylinder DW 50-100-900CB	50	100	900	30,3 / 30,3	250	1125
Zylinder DW 60-100-200ST	60	100	200	40,4 / 40,4	250	436
Zylinder DW 60-100-400ST	60	100	400	40,4 / 40,4	250	636
Zylinder DW 60-100-600ST	60	100	600	40,4 / 40,4	250	836
Zylinder DW 60-100-800ST	60	100	800	40,4 / 40,4	250	1036
Zylinder DW 60-100-1000ST	60	100	1000	40,4 / 40,4	250	1236

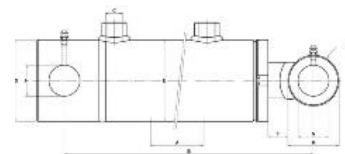



Hydraulikzylinder GK doppelwirkend mit Befestigung (Gelenkkopf)

Bestell-Nr.	Ø Stange mm	Ø Kolben mm	Hub mm	Ø Bolzen mm	Druck max. bar	Einbaumaß mm
Zylinder DW 16-25-100GK	16	25	100	15 / 15	250	267
Zylinder DW 16-25-150GK	16	25	150	15 / 15	250	317
Zylinder DW 16-25-200GK	16	25	200	15 / 15	250	367
Zylinder DW 16-25-250GK	16	25	250	15 / 15	250	417
Zylinder DW 20-32-100GK	20	32	100	15 / 15	250	273
Zylinder DW 20-32-150GK	20	32	150	15 / 15	250	323
Zylinder DW 20-32-200GK	20	32	200	15 / 15	250	373
Zylinder DW 20-32-250GK	20	32	250	15 / 15	250	423
Zylinder DW 20-32-300GK	20	32	300	15 / 15	250	473
Zylinder DW 20-32-350GK	20	32	350	15 / 15	250	523
Zylinder DW 20-32-400GK	20	32	400	15 / 15	250	573
Zylinder DW 20-32-500GK	20	32	500	15 / 15	250	673
Zylinder DW 25-40-100GK	25	40	100	20 / 20	250	292
Zylinder DW 25-40-150GK	25	40	150	20 / 20	250	342
Zylinder DW 25-40-200GK	25	40	200	20 / 20	250	392
Zylinder DW 25-40-250GK	25	40	250	20 / 20	250	442
Zylinder DW 25-40-300GK	25	40	300	20 / 20	250	492
Zylinder DW 25-40-350GK	25	40	350	20 / 20	250	542
Zylinder DW 25-40-400GK	25	40	400	20 / 20	250	592
Zylinder DW 25-40-500GK	25	40	500	20 / 20	250	692
Zylinder DW 25-40-600GK	25	40	600	20 / 20	250	792
Zylinder DW 25-40-700GK	25	40	700	20 / 20	250	892
Zylinder DW 30-50-100GK	30	50	100	25 / 25	250	314
Zylinder DW 30-50-150GK	30	50	150	25 / 25	250	364
Zylinder DW 30-50-200GK	30	50	200	25 / 25	250	414
Zylinder DW 30-50-250GK	30	50	250	25 / 25	250	464
Zylinder DW 30-50-300GK	30	50	300	25 / 25	250	514
Zylinder DW 30-50-350GK	30	50	350	25 / 25	250	564
Zylinder DW 30-50-400GK	30	50	400	25 / 25	250	614
Zylinder DW 30-50-500GK	30	50	500	25 / 25	250	714
Zylinder DW 30-50-600GK	30	50	600	25 / 25	250	814
Zylinder DW 30-50-700GK	30	50	700	25 / 25	250	914
Zylinder DW 30-50-800GK	30	50	800	25 / 25	250	1014

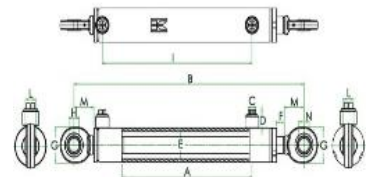



Hydraulikzylinder GK doppelwirkend mit Befestigung (Gelenkkopf)

Bestell-Nr.	Ø Stange mm	Ø Kolben mm	Hub mm	Ø Bolzen mm	Druck max. bar	Einbaumaß mm
Zylinder DW 30-60-100GK	30	60	100	30 / 30	250	338
Zylinder DW 30-60-150GK	30	60	150	30 / 30	250	388
Zylinder DW 30-60-200GK	30	60	200	30 / 30	250	438
Zylinder DW 30-60-250GK	30	60	250	30 / 30	250	488
Zylinder DW 30-60-300GK	30	60	300	30 / 30	250	538
Zylinder DW 30-60-350GK	30	60	350	30 / 30	250	588
Zylinder DW 30-60-400GK	30	60	400	30 / 30	250	638
Zylinder DW 30-60-500GK	30	60	500	30 / 30	250	738
Zylinder DW 30-60-600GK	30	60	600	30 / 30	250	838
Zylinder DW 30-60-700GK	30	60	700	30 / 30	250	938
Zylinder DW 30-60-800GK	30	60	800	30 / 30	250	1038
Zylinder DW 35-70-100GK	35	70	100	35 / 35	250	360
Zylinder DW 35-70-150GK	35	70	150	35 / 35	250	410
Zylinder DW 35-70-200GK	35	70	200	35 / 35	250	460
Zylinder DW 35-70-250GK	35	70	250	35 / 35	250	510
Zylinder DW 35-70-300GK	35	70	300	35 / 35	250	560
Zylinder DW 35-70-350GK	35	70	350	35 / 35	250	610
Zylinder DW 35-70-400GK	35	70	400	35 / 35	250	660
Zylinder DW 35-70-500GK	35	70	500	35 / 35	250	760
Zylinder DW 35-70-600GK	35	70	600	35 / 35	250	860
Zylinder DW 35-70-700GK	35	70	700	35 / 35	250	960
Zylinder DW 35-70-800GK	35	70	800	35 / 35	250	1060
Zylinder DW 45-80-100GK	45	80	100	40 / 40	250	394
Zylinder DW 45-80-150GK	45	80	150	40 / 40	250	444
Zylinder DW 45-80-200GK	45	80	200	40 / 40	250	494
Zylinder DW 45-80-250GK	45	80	250	40 / 40	250	544
Zylinder DW 45-80-300GK	45	80	300	40 / 40	250	594
Zylinder DW 45-80-350GK	45	80	350	40 / 40	250	644
Zylinder DW 45-80-400GK	45	80	400	40 / 40	250	694
Zylinder DW 45-80-500GK	45	80	500	40 / 40	250	794
Zylinder DW 45-80-600GK	45	80	600	40 / 40	250	894
Zylinder DW 45-80-700GK	45	80	700	40 / 40	250	994
Zylinder DW 45-80-800GK	45	80	800	40 / 40	250	1094

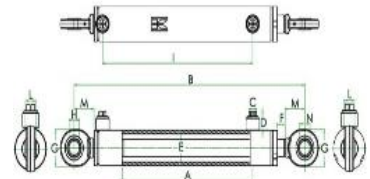

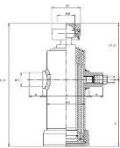

Teleskopzylinder mit Kugel und Pfanne 2stufig						
Bestell-Nr.	Stufen mm 2stufig	Druck bar	Hub mm	seitlicher Bolzen Ø	Abstand zwischen den Bolzen	Einbaumaß mm
Zylinder TC2020	46/61	180	455	35	100	340
Zylinder TC3021	61/76	180	495	35	115	412
Zylinder TC3022	61/76	180	595	35	115	460
Zylinder TC3023	61/76	180	695	35	115	510
Zylinder TC3024	61/76	180	795	35	115	560
Zylinder TC3026	61/76	180	995	35	115	665
Zylinder TC4021	68/88	180	595	35	130	465
Zylinder TC4024	68/88	180	795	35	130	520
Zylinder TC4023	88/107	180	695	40	150	565
Zylinder TC4027	88/107	180	1095	40	150	720

Teleskopzylinder mit Kugel und Pfanne 3stufig						
Bestell-Nr.	Stufen mm 3stufig	Druck bar	Hub mm	seitlicher Ø Bolzen	Abstand zwischen den Bolzen	Einbaumaß mm
Zylinder TC2031	46/61/76	180	500	35	115	322
Zylinder TC2032	46/61/76	180	593	35	115	352
Zylinder TC2033	46/61/76	180	683	35	115	382
Zylinder TC2034	46/61/76	180	790	35	115	417
Zylinder TC2035	46/61/76	180	893	35	115	452
Zylinder TC2036	46/61/76	180	1043	35	115	502
Zylinder TC2038	46/61/76	180	1490	35	115	652
Zylinder TC3031	61/76/91	180	593	35	135	367
Zylinder TC3032	61/76/91	180	683	35	135	397
Zylinder TC3033	61/76/91	180	785	35	135	432
Zylinder TC3034	61/76/91	180	893	35	135	467
Zylinder TC3035	61/76/91	180	1043	35	135	517
Zylinder TC3036	61/76/91	180	1283	35	135	597
Zylinder TC3037	61/76/91	180	1493	35	135	667
Zylinder TC4031	68/88/107	180	743	40	150	417
Zylinder TC4032	68/88/107	180	785	40	150	432
Zylinder TC4033	68/88/107	180	893	40	150	467
Zylinder TC4034	68/88/107	180	1043	40	150	517
Zylinder TC4035	68/88/107	180	1283	40	150	597
Zylinder TC4036	88/107/126	180	1273	45	175	610
Zylinder TC4038	88/107/126	180	1483	45	175	680



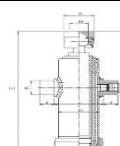

Teleskopzylinder mit Kugel und Pfanne 4stufig						
Bestell-Nr.	Stufen mm 4stufig	Druck bar	Hub mm	seitlicher Ø Bolzen	Abstand zwischen den Bolzen	Einbaumaß mm
Zylinder TC3041	61/76/91/107	180	670	40	150	382
Zylinder TC3042	61/76/91/107	180	830	40	150	382
Zylinder TC3043	61/76/91/107	180	950	40	150	412
Zylinder TC3044	61/76/91/107	180	1050	40	150	437
Zylinder TC3045	61/76/91/107	180	1190	40	150	472
Zylinder TC3046	61/76/91/107	180	1290	40	150	497
Zylinder TC3047	61/76/91/107	180	1510	40	150	552
Zylinder TC3048	61/76/91/107	180	1710	40	150	602
Zylinder TC3049	61/76/91/107	180	1990	40	150	672
Zylinder TC3063	46/61/76/91	180	790	35	135	360
Zylinder TC3065	46/61/76/91	180	1050	35	135	425
Zylinder TC4041	68/88/107/126	180	1040	45	175	440
Zylinder TC4042	68/88/107/126	180	1220	45	175	487
Zylinder TC4043	68/88/107/126	180	1500	45	175	557
Zylinder TC4044	68/88/107/126	180	1700	45	175	607
Zylinder TC4045	88/107/126/145	180	1490	50	210	564
Zylinder TC4046	88/107/126/145	180	1690	50	210	614
Zylinder TC4047	88/107/126/145	180	1970	50	210	684
Zylinder TC4048	107/126/145/165	180	1920	50	230	698



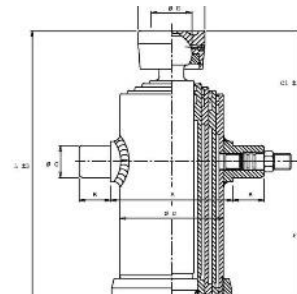

Teleskopzylinder mit Kugel und Pfanne 5stufig

Bestell-Nr.	Stufen mm 5stufig	Druck bar	Hub mm	seitlicher Ø Bolzen	Abstand zwischen den Bolzen	Einbaumaß mm
Zylinder TC3050	46/61/76/91/107	180	690	40	150	305
Zylinder TC3051	61/76/91/107/126	180	980	45	175	380
Zylinder TC3052	61/76/91/107/126	180	1230	45	175	430
Zylinder TC3053	61/76/91/107/126	180	1480	45	175	480
Zylinder TC3054	61/76/91/107/126	180	1880	45	175	560
Zylinder TC3055	61/76/91/107/126	180	2130	45	175	610
Zylinder TC3056	61/76/91/107/126	180	2480	45	175	680
Zylinder TC3092	46/61/76/91/107	180	1040	40	150	373
Zylinder TC3093	46/61/76/91/107	180	1190	40	150	405
Zylinder TC4050	68/88/107/126/145	180	1870	50	210	565
Zylinder TC4051	68/88/107/126/145	180	2120	50	210	615
Zylinder TC4052	88/107/126/145/165	180	2100	50	230	615
Zylinder TC4053	88/107/126/145/165	180	2450	50	230	695
Zylinder TC5002	68/88/107/126/145	180	2470	50	210	685
Zylinder TC5010	88/107/126/145/165	180	3490	50	230	915
Zylinder TC5034	107/126/145/165/187	180	2005	50	252	633

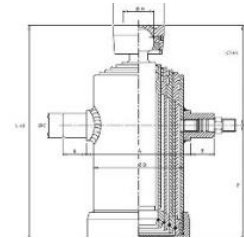

Teleskopzylinder mit Kugel und Pfanne 6stufig

Bestell-Nr.	Stufen mm 6stufig	Druck bar	Hub mm	seitlicher Ø Bolzen	Abstand zwischen den Bolzen	Einbaumaß mm
Zylinder TC4060	68/88/107/126/145/165	180	2225	50	230	573
Zylinder TC4061	68/88/107/126/145/165	180	2490	50	230	623
Zylinder TC4062	68/88/107/126/145/165	180	2910	50	230	693
Zylinder TC4063	68/88/107/126/145/165	180	3405	50	230	789
Zylinder TC4059	68/88/107/126/145/165	180	1810	50	230	503
Zylinder TC6012	46/61/76/91/107/126	180	2977	45	175	668
Zylinder TC6020	61/76/91/107/126/145	180	1465	50	210	430
Zylinder TC6024	61/76/91/107/126/145	180	2955	50	210	680
Zylinder TC6056	88/107/126/145/165/187	180	3265	50	252	785

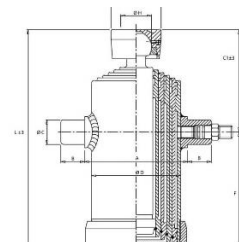



Teleskopzylinder mit Auge 2stufig

Bestell-Nr.	Stufen mm 2stufig	Druck bar	Hub mm	seitlicher Ø Bolzen	Abstand zwischen den Bolzen	Einbaumaß mm
Zylinder TC2020F	46/61	180	455	35	100	380
Zylinder TC2021F	46/61	180	525	35	100	375
Zylinder TC3022F	61/76	180	595	35	115	415
Zylinder TC3023F	61/76	180	695	35	115	465
Zylinder TC3024F	61/76	180	795	35	115	515
Zylinder TC4026F	88/107	180	895	40	150	580
Zylinder TG4027F	88/107	180	1095	40	150	680

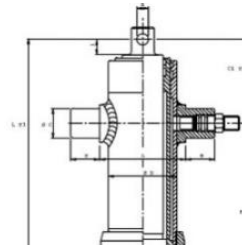

Teleskopzylinder mit Auge 3stufig

Bestell-Nr.	Stufen mm 3stufig	Druck bar	Hub mm	seitlicher Ø Bolzen	Abstand zwischen den Bolzen	Einbaumaß mm
Zylinder TC2031F	46/61/76	180	500	35	115	282
Zylinder TC2032F	46/61/76	180	593	35	115	312
Zylinder TC2034F	46/61/76	180	790	35	115	377
Zylinder TC2036F	46/61/76	180	1043	35	115	462
Zylinder TC3030F	61/76/91	180	500	35	135	292
Zylinder TC3034F	61/76/91	180	893	35	135	422
Zylinder TC3035F	61/76/91	180	1043	35	135	472
Zylinder TC4033F	68/88/107	180	893	40	150	438
Zylinder TC4034F	68/88/107	180	1043	40	150	482
Zylinder TC4035F	68/88/107	180	1283	40	150	562
Zylinder TC4036F	88/107/126	180	1273	45	175	570
Zylinder TC4038F	88/107/126	180	1483	45	175	637

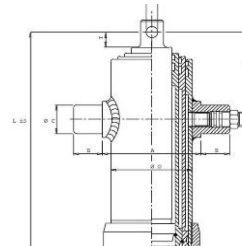



Teleskopzylinder mit Auge 4stufig

Bestell-Nr.	Stufen mm 4stufig	Druck bar	Hub mm	seitlicher Ø Bolzen	Abstand zwischen den Bolzen	Einbaumaß mm
Zylinder TC3042F	61/76/91/107	180	830	40	150	337
Zylinder TC3043F	61/76/91/107	180	950	40	150	367
Zylinder TC3044F	61/76/91/107	180	1050	40	150	392
Zylinder TC3045F	61/76/91/107	180	1190	40	150	427
Zylinder TC3046F	61/76/91/107	180	1290	40	150	452
Zylinder TC3047F	61/76/91/107	180	1510	40	150	507
Zylinder TC3048F	61/76/91/107	180	1710	40	150	557
Zylinder TC3049F	61/76/91/107	180	1990	40	150	627
Zylinder TC4042F	68/88/107/126	180	1220	45	175	455
Zylinder TC4043F	68/88/107/126	180	1500	45	175	525
Zylinder TC4044F	68/88/107/126	180	1700	45	175	575
Zylinder TC4045F	88/107/126/145	180	1490	50	210	520
Zylinder TC4046F	88/107/126/145	180	1690	50	210	570
Zylinder TC4047F	88/107/126/145	180	1970	50	210	640
Zylinder TC4048F	107/126/145/165	180	1920	50	230	657
Zylinder TC4072F	88/107/126/145	180	1210	50	210	490
Zylinder TC4083F	107/126/145/165	180	1670	50	230	628

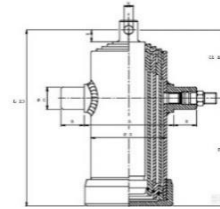

Teleskopzylinder mit Auge 5stufig

Bestell-Nr.	Stufen mm 5stufig	Druck bar	Hub mm	seitlicher Ø Bolzen	Abstand zwischen den Bolzen	Einbaumaß mm
Zylinder TC3053F	61/76/91/107/126	180	1480	45	175	435
Zylinder TC3054F	61/76/91/107/126	180	1880	45	175	515
Zylinder TC3055F	61/76/91/107/126	180	2130	45	175	565
Zylinder TC3056F	61/76/91/107/126	180	2480	45	175	635
Zylinder TC3096F	46/61/76/91/107	180	2490	40	150	625
Zylinder TC4051F	68/88/107/126/145	180	2120	50	210	575
Zylinder TC4052F	88/107/126/145/165	180	2100	50	230	575
Zylinder TC4053F	88/107/126/145/165	180	2450	50	230	655
Zylinder TC5002F	68/88/107/126/145	180	2470	50	210	645
Zylinder TC5011F	88/107/126/145/165	180	2990	50	230	775

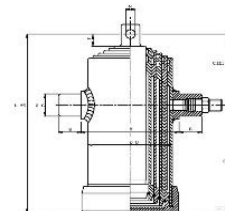



Teleskopzylinder mit Auge 6stufig

Bestell-Nr.	Stufen mm 6stufig	Druck bar	Hub mm	seitlicher Ø Bolzen	Abstand zwischen den Bolzen	Einbaumaß mm
Zylinder TC4060F	68/88/107/126/145/165	180	2225	50	230	533
Zylinder TC4061F	68/88/107/126/145/165	180	2490	50	230	587
Zylinder TC4062F	68/88/107/126/145/165	180	2910	50	230	653
Zylinder TC4065F	68/88/107/126/145/165	180	3765	50	230	815
Zylinder TC6025F	61/76/91/107/126/145	180	3585	50	210	768

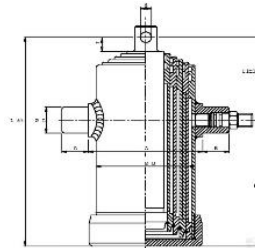

Bremszylinder Typ EPL ohne Federrückstellung einfachwirkend

Bestell-Nr.	Stange Ø	Anschluss	Hub mm	Nenndruck bar	Länge
Zylinder EPL30110	30		110	200	232

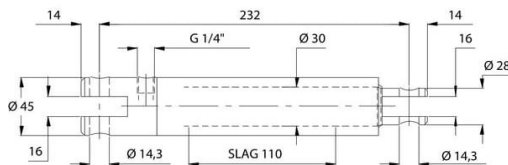

Bremszylinder Typ BC ohne Federrückstellung einfachwirkend

Bestell-Nr.	Stange Ø	Anschluss	Hub mm	Nenndruck bar	Länge
Zylinder BC20100	20	3/8" BSP	100	200	235
Zylinder BC25100	25	3/8" BSP	100	200	235
Zylinder BC30100	30	3/8" BSP	100	200	250
Zylinder BC2580	25	3/8" BSP	80	200	270

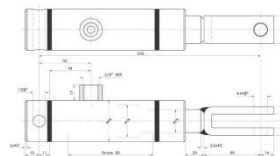
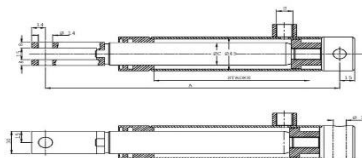



Bremszylinder Typ BCS mit Federrückstellung einfachwirkend

Bestell-Nr.	Stange Ø	Anschluss	Hub mm	Nenndruck bar	Länge
Zylinder BCS20100	20	3/8" BSP	100	200	300
Zylinder BCS25100	25	3/8" BSP	100	200	300
Zylinder BCS30100	30	3/8" BSP	100	200	300
Zylinder BCS2595	25	3/8" BSP	95	200	240
Zylinder BCS2580	25	3/8" BSP	80	250	240

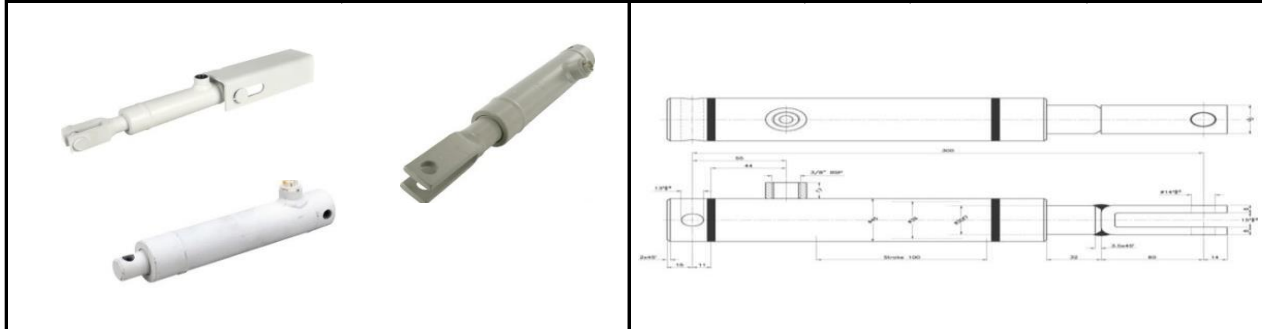

Bremszylinder Typ BC mit Federrückstellung einfachwirkend mit Bodengewinde M 16x1,5

Bestell-Nr.	Stange Ø	Anschluss	Hub mm	Nenndruck bar	Länge
Zylinder BC2080TH	20	3/8" BSP	80	180	210
Zylinder BC2580TH	25	3/8" BSP	80	180	230
Zylinder BC3080TH	30	3/8" BSP	80	180	230

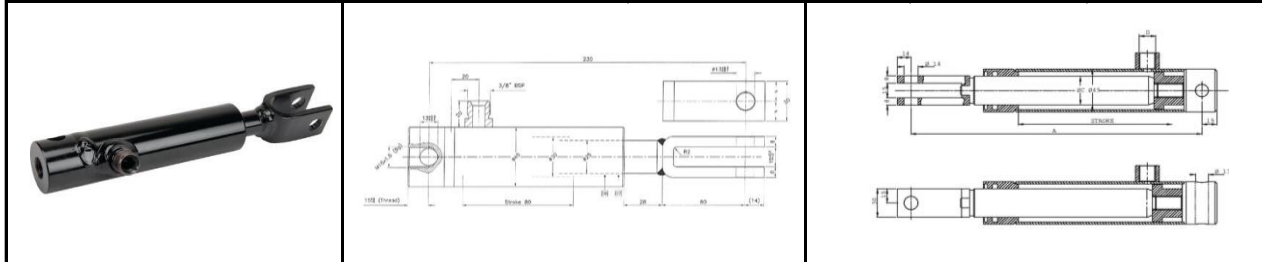

Bremszylinder Typ BCB einfachwirkend

Bestell-Nr.	Stange Ø	Anschluss	Hub mm	Nenndruck bar	Länge
Zylinder BC2098	20	3/8" BSP	98	180	239
Zylinder BC2598	25	3/8" BSP	98	180	239
Zylinder BC3098	30	3/8" BSP	98	180	239





Hydraulischer Oberlenker-Zylinder doppelwirkend

Bestell-Nr.	Ø Stange mm	Ø A mm	Hub mm	Ø Bolzen mm	Druck max bar	Einbaumaß mm
Oberlenker-Zylinder DW	30	60	100	19,4 / 19,4	250	340
Oberlenker-Zylinder DW	30	60	150	19,4 / 19,4	250	390
Oberlenker-Zylinder DW	30	60	200	19,4 / 19,4	250	440
Oberlenker-Zylinder DW	30	60	200	25,7 / 25,7	250	440
Oberlenker-Zylinder DW	30	60	285	19,4 / 19,4	250	550
Oberlenker-Zylinder DW	30	60	285	25,7 / 25,7	250	550
Oberlenker-Zylinder DW	30	60	350	25,7 / 25,7	250	610
Oberlenker-Zylinder DW	35	70	250	25,7 / 25,7	250	550
Oberlenker-Zylinder DW	35	70	300	25,7 / 25,7	250	580
Oberlenker-Zylinder DW	35	70	250	25,7 / 25,7	250	550

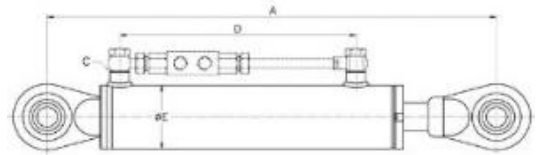

Hydraulischer Oberlenker-Zylinder mit Fanghaken doppelwirkend

Bestell-Nr.	Ø Stange mm	Ø A mm	Hub mm	Ø Bolzen mm	Druck max. bar	Einbaumaß mm
Zylinder DW/Fanghaken	30	60	150	19,4 / 19,4	250	440
Zylinder DW/Fanghaken	30	60	200	19,4 / 19,4	250	490
Zylinder DW/Fanghaken	30	60	285	25,7 / 25,7	250	590
Zylinder DW/Fanghaken	35	73	230	25,7 / 25,7	250	546
Zylinder DW/Fanghaken	35	73	300	25,7 / 25,7	250	620
Zylinder DW/Fanghaken	35	80	250	25,7 / 25,7	250	610
Zylinder DW/Fanghaken	35	80	250	31,6 / 31,6	250	630
Zylinder DW/Fanghaken	35	80	300	25,7 / 25,7	250	640
Zylinder DW/Fanghaken	35	80	300	31,6 / 31,6	250	660

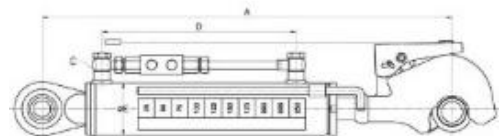



Hydraulischer Oberlenker-Zylinder mit Schlauch doppelwirkend

Bestell-Nr.	Ø Stange mm	Ø A mm	Hub mm	Ø Bolzen mm	Druck max. bar	Einbaumaß mm
Zylinder DW/Schlauch	30	60	150	19,4 / 19,4	250	440
Zylinder DW/Schlauch	35	73	230	25,7 / 25,7	250	546
Zylinder DW/Schlauch	35	73	300	25,7 / 25,7	250	620

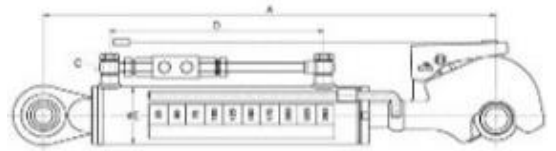

Hydraulischer Oberlenker-Zylinder Kat. 1 mit Schlauch doppelwirkend

Bestell-Nr.	Ø Stange mm	Ø A mm	Hub mm	Ø Bolzen mm	Druck max. bar	Einbaumaß mm
Zylinder Schlauch/Kat.1	30	60	150	19,4 / 19,4	250	390
Zylinder Schlauch/Kat.1	30	60	200	19,4 / 19,4	250	440

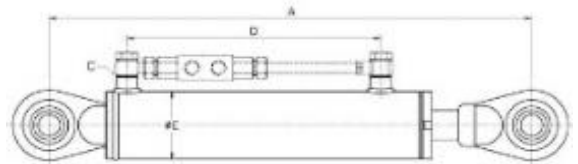

Hydraulischer Oberlenker-Zylinder mit Bohrung doppelwirkend

Bestell-Nr.	Ø Stange mm	Ø A mm	Hub mm	Ø Bolzen mm	Druck max. bar	Einbaumaß mm
Zylinder DW / Bohrung	35	73	180	20 / 20	250	505
Zylinder DW / Bohrung	35	73	230	20 / 20	250	555
Zylinder DW / Bohrung	35	80	185	25 / 25	250	540
Zylinder DW / Bohrung	40	103	185	25 / 25	250	565

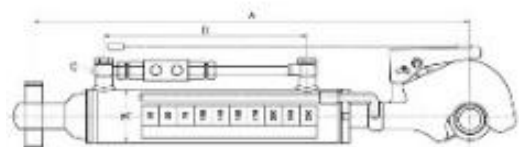



Hydraulischer Gülletankzylinder doppelwirkend 6"

Bestell-Nr.	Ø Stange mm	Ø A mm	Hub mm	Ø I mm	Druck max. bar	Einbaumaß mm
Gülletankzylinder 6"	25	50	150	40	250	360

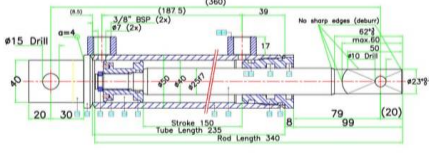
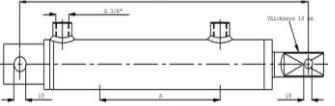
Kompaktzylinder für Gülletank einfachwirkend 6"

Bestell-Nr.	Ø Stange mm	Ø A mm	Hub mm	ges. Länge mm	Druck max. bar	Befestig.
Kompaktzylinder 6"	16	55	100	217	200	M30 x 2
Kompaktzylinder 6"	16	55	150	246	200	M30 x 2
Kompaktzylinder 6"	16	55	200	284,5	200	M30 x 2

Hydraulikzylinder (Gasdruck) für Gülletank einfachwirkend mit Außengewinde

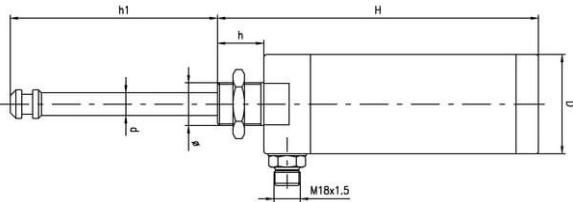
Bestell-Nr.	Ø Stange mm	Ø A mm	Hub mm	Länge o. Stange	Ölanschluss	Gewinde
Zylinder 4"	16	46	133	457	402	AG
Zylinder 5"		46	157	457	402	AG
Zylinder 6"	16	46	189	492	436	M30 x 2
Zylinder 8"		46	242	865	813	AG
Zylinder 8"		46	213	567	503	AG



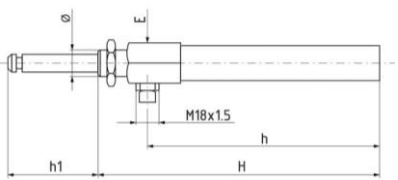
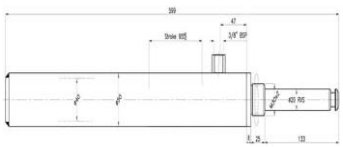

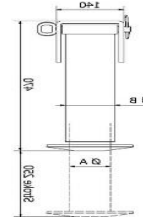
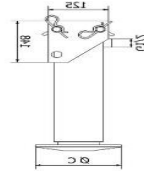

Hydraulikzylinder Stützfußzylinder						
Bestell-Nr.	Ø Zylinder mm	Befestigung Ø mm	Hub mm	Fußplatte Ø	Nenndruck bar	Inhalt l
Stützfußzylinder 65-250	80	65	250	160	200	0,83
Stützfußzylinder 85-250	100	85	250	180	200	1,42

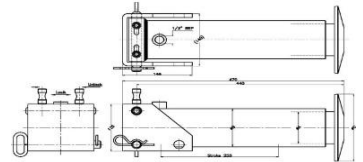
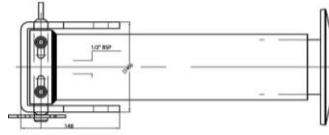
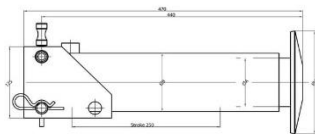

Hydraulikzylinder Stützfußzylinder mit Schnellverschluss						
Bestell-Nr.	Ø Zylinder mm	Befestigung Ø mm	Hub mm	Fußplatte Ø	Nenndruck bar	Inhalt l
Zylinder 65-250CS	82	65	250	160	200	0,91
Zylinder 85-250CS	100	85	250	180	200	1,42



Stützfußzylinder mit Handpumpe						
Bestell-Nr.	Ø Stange mm	Kapazität to	Hub mm	max. Betriebs- druck bar	Nenndruck bar	Hebekraft KG
Zylinder Handpumpe 3,3	65	3,3	250	250	200	20
Zylinder Handpumpe 5,7	85	5,7	250	250	200	20

